

QUICK START GUIDE

49" 4,000 nits High Brightness Digital Signage



WARRANTY POLICY

Please visit our website to get more information.
<http://www.dynascandisplay.com/support/warranty/>

DynaScan

V1.00

1

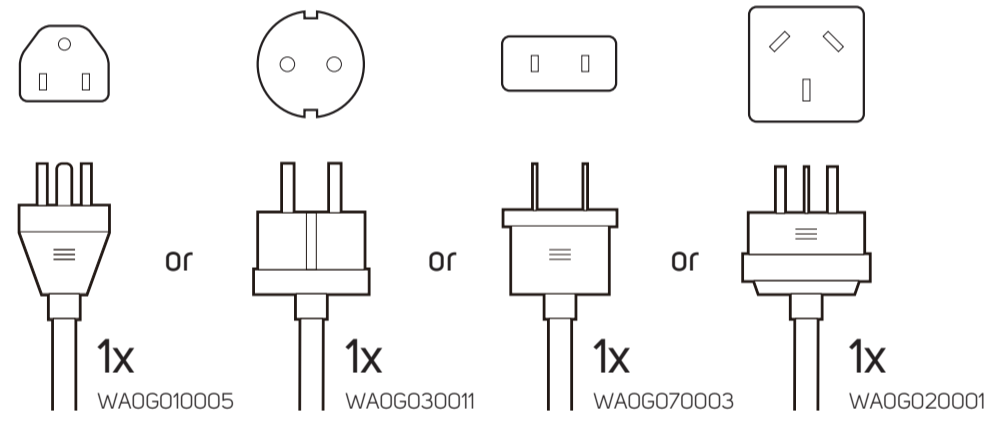
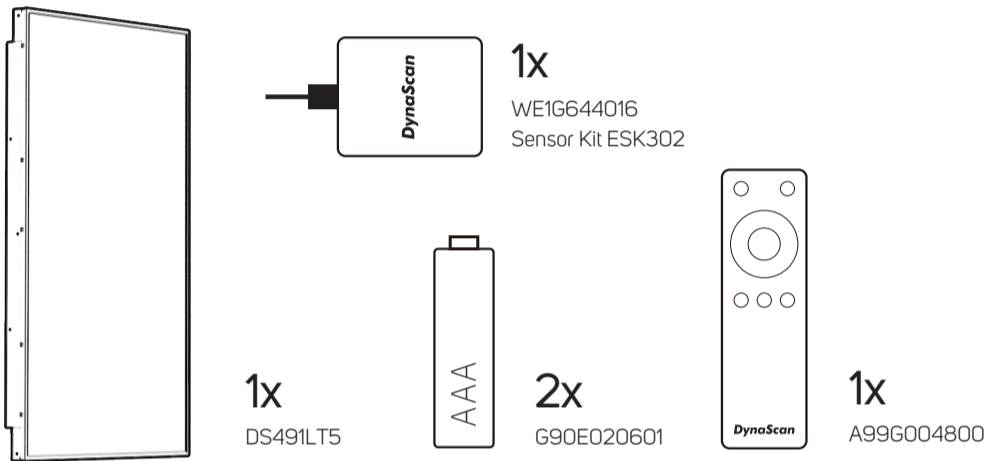

2

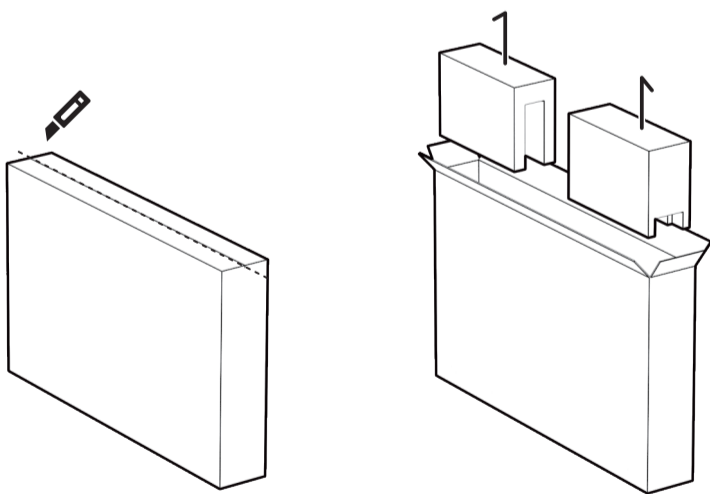

3

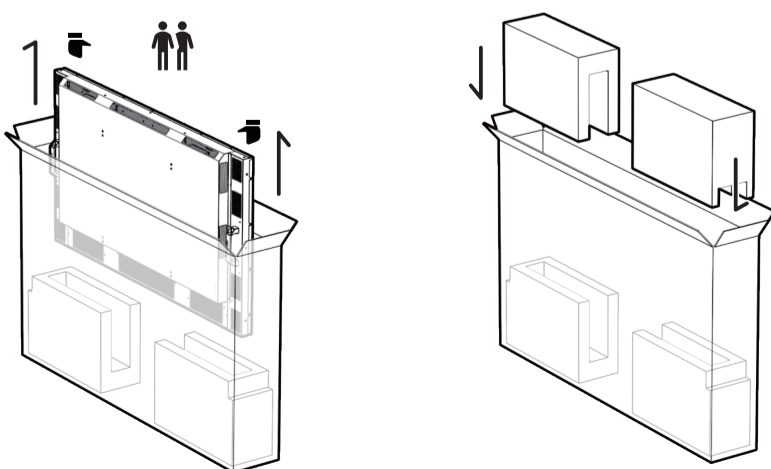

4

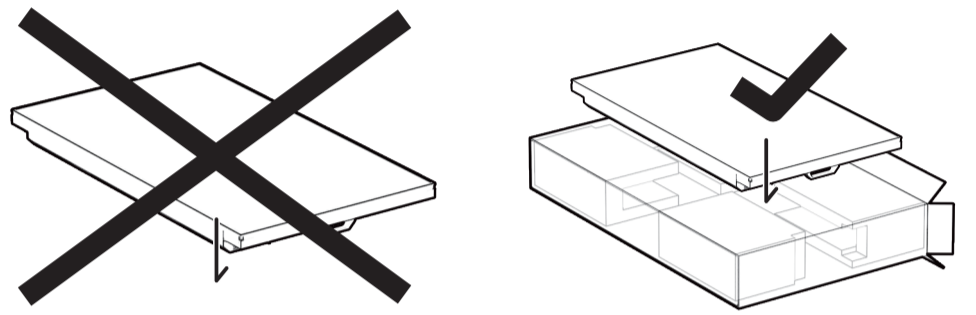

5

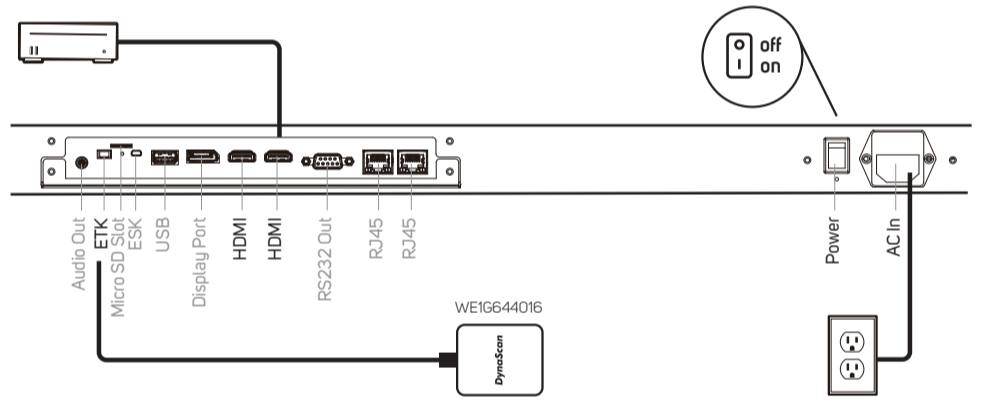

6

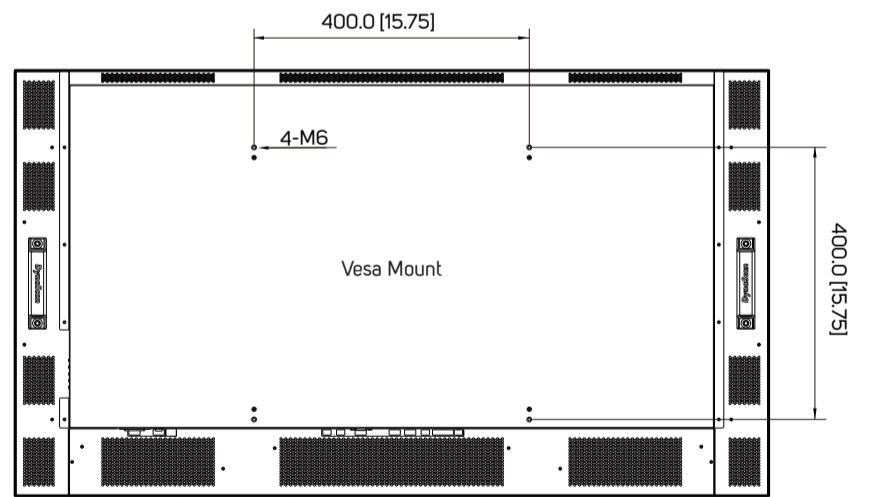

7

